

 Use glue on the connecting openings

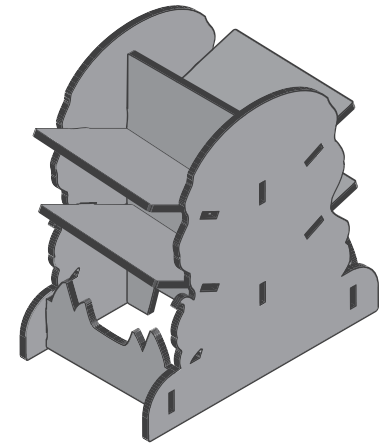

Please remove elements out of frame carefully.
It is recommended to use a blade at the cutline to punch the element out of the sheet easier

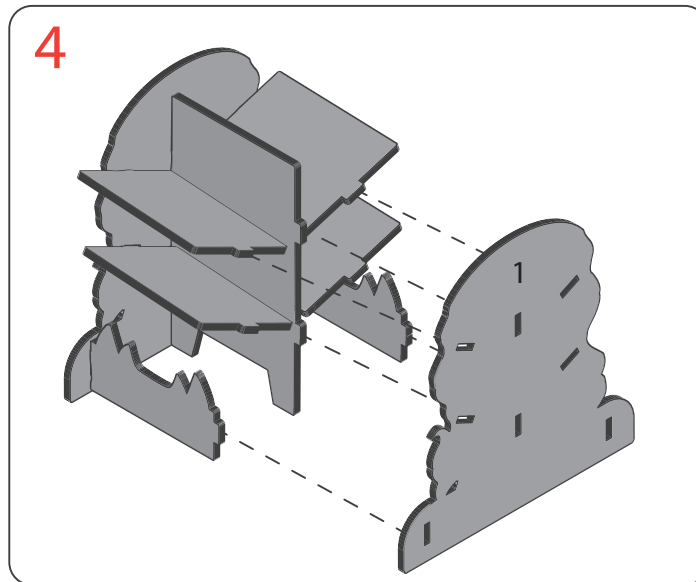
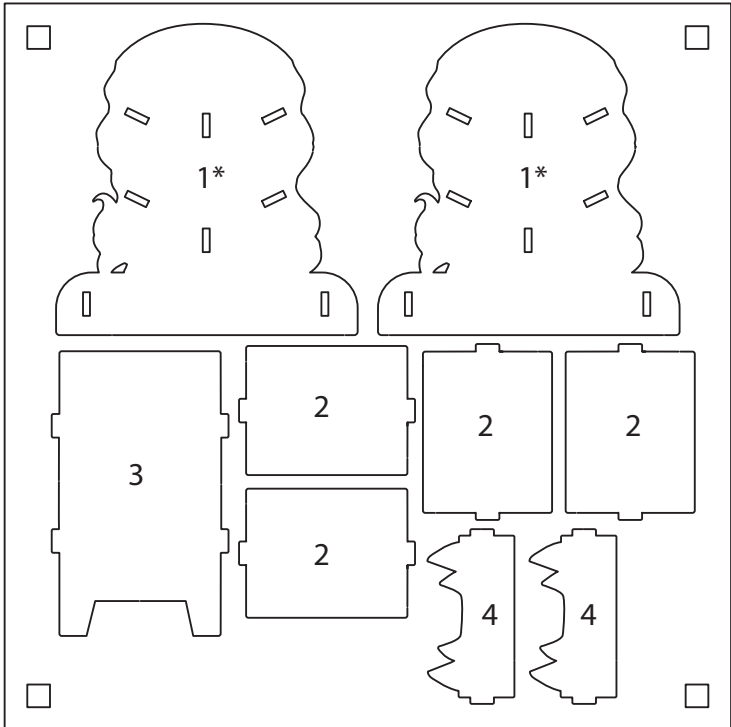
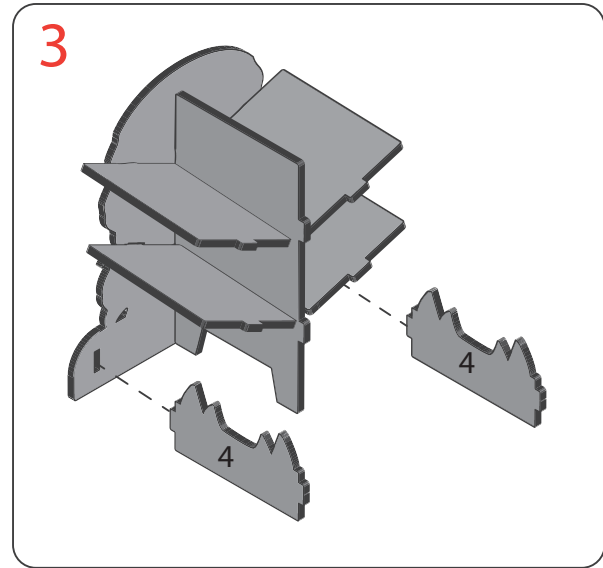
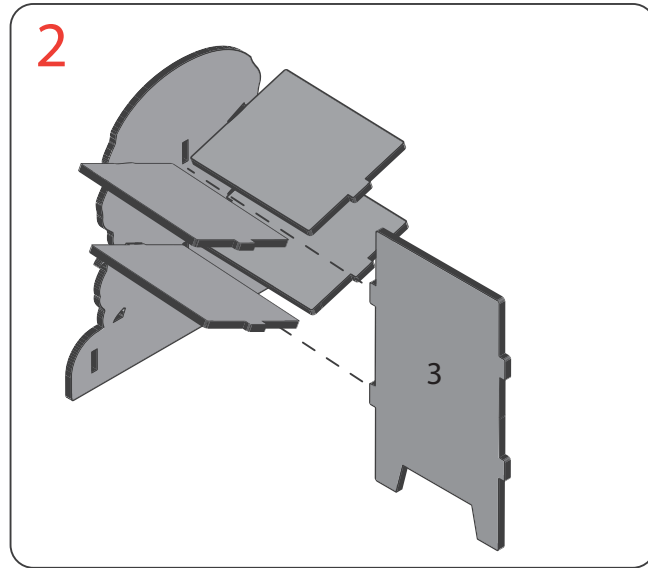
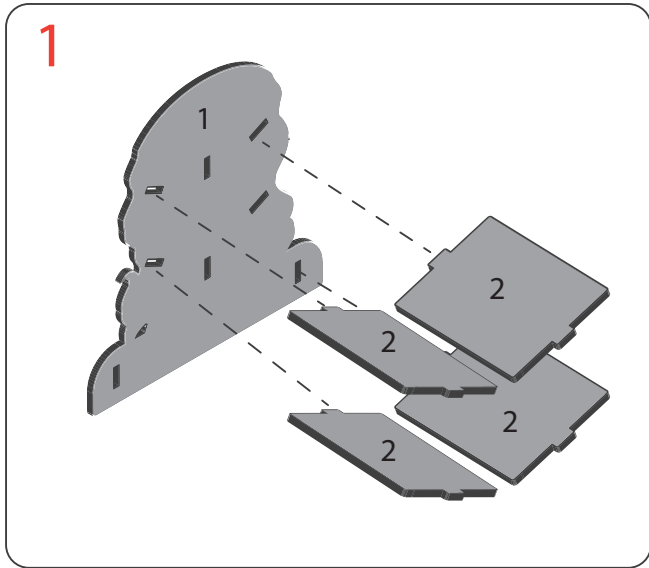

*The shape of element 1 differs depending on design